



MADE IN
THE UK

Taking Life Outdoors

Verandas, Glass Rooms & Aluminium Fencing
Outdoor Living Solutions to suit every home!



The first step in finding your new outdoor living Veranda or Glass Room solution begins here

The following range of outdoor living products are manufactured entirely from aluminium and supplied at the highest quality. Built to last, they are highly versatile with bespoke specifications available to achieve your dream results.

- **Made from High Quality Aluminium Material**
- **Exclusively made in the UK**
- **Competitive lead times**



Contents

Our Range	3-4	Sim 16 Glass Room	23-24
Verandas & Canopies	5-6	Sim 35 Glass Room	25-26
Sim 6 Veranda	7-8	Sim Xtra Glass Room	27-28
Sim 16 Veranda	9-10	Sim Free Glass Room	29-30
Sim 35 Veranda	11-12	Alfresco Glass Room	31-32
Sim Xtra Veranda	13-14	Victorian Upgrades	33-34
Sim Free Veranda	15-16	Heating	35-36
Alfresco Veranda	17-18	LED Lighting	37-38
Glass Rooms	19-20	LED Spotlights	39-40
Sim 6 Glass Room	21-22	A-Fence	41-42



Our Range

We are proud to offer the most innovative, versatile, and modular aluminium outdoor living solutions to both domestic homes and commercial properties. Capable of meeting any bespoke requests, we're sure that you will find the right solution to help create your dream outdoor living space.

Contained within this brochure are a range of robust products that come with a minimum 60-year life expectancy and 10-year manufacturer guarantee to offer you full peace of mind.

Manufactured in the UK, these systems are created using the new de facto standard material across the industry; aluminium. Not only does aluminium require little-to-no maintenance outside of regular cleaning, but users will be able to use their outdoor living space all year round free from the elements with a variety of design features and optional upgrades available upon request.

You can choose from a variety of design options including verandas,

canopies, or glass rooms that can be wall-mounted or free-standing.

Depending on the needs of your property or desired project outcome, you can also choose from open-plan, semi-enclosed, or glass room design that works within your specified budget with all options guaranteed to offer you a true return on your investment.

Thousands of homeowners have already benefited from adding more usable living space to their homes. The housing and commercial property market is also widely known to be on the rise with demand at an all-time high. Therefore, now is a suitable time to explore the various ways of creating additional value for your property.

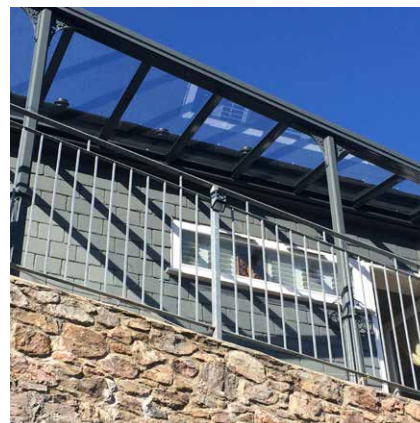

Benefits include:

- **Minimum 60-year life** expectancy
- **10-year** manufacturer guarantee
- **Bespoke** to suit your needs and dream outcome
- **Cost-effective** solutions for all budgets
- Durable and aesthetically pleasing **Textured Powder-coat finish**



Verandas & Canopies

Invite the great outdoors into your home by removing any fear of the elements intruding while having your patio or French doors open, or simply relax outdoors under a robust sheltered space with a variety of protection levels available to suit the needs of your property or location.

Our Aluminium Verandas are affordable, functional, and stylish with a range of glazing options available. Ideal for the rear elevation of any property, a veranda is the ideal living solution for those looking to extend their usable outdoor living space into the garden.

- **Easy to install**, and easy to enjoy – enquire today!
- **Designed** with both domestic home and commercial property owners in mind.
- Enjoy your patio & garden all year round with friends & family, perfect for outdoor dining, entertaining or relaxing & increase the **value of your home!**

Capable of spanning up to a massive 6 metres from post to post, you'll be able to enjoy a panoramic view that is uncompromised. Highly versatile and cost-effective, our verandas can be custom designed to integrate seamlessly to areas large or small.

We also have glazing options for the ceiling, side walls, and front elevations that can offer glass room or semi-enclosed design provides an aesthetically pleasing finish with uninterrupted views. See pages 19-32 for more on this.

With a range of upgrades and accessories available, including LED

The benefits of using a polycarbonate roofing option include:

- **Cost-effective** alternative to glass
- **UV Protection** elements
- Durable yet lightweight to support **hassle-free installation**
- **Longevity** - designed to last, withstanding the test of time and the unpredictable weather across the UK & Ireland

lighting, glazing options, heating, drainage solutions, and more, your new veranda system can be easily tailored to meet your desired requirements.

Manufactured in the UK through our trusted supplier who have over 25 years of experience within the glazing and home improvements industry, we ensure the highest quality outdoor living verandas to both domestic home and commercial property owners.

Through unique and clever design combined with a high-quality powder-coat finish, you can be sure that your veranda or canopy will seamlessly integrate into any traditional or modern property and last for decades.

If you're looking to create a new sheltered space for the front or side elevation or looking for a veranda solution to suit a lower budget, why not consider one of our canopies finished in polycarbonate roofing?

Using the aluminium frame as our verandas, you'll still benefit from many of the excellent benefits our verandas offer, including all optional upgrades. Polycarbonate roofing simply caters for those on a stricter budget or looking for a lightweight alternative, without any significant compromise to the durability of the product.

The polycarbonate roofing is available in clear, opal, and bronze as standard with the option to upgrade to 16mm grey heat-guard option. These can also help protect against discolouration allowing for an aesthetically pleasing finish long-term.

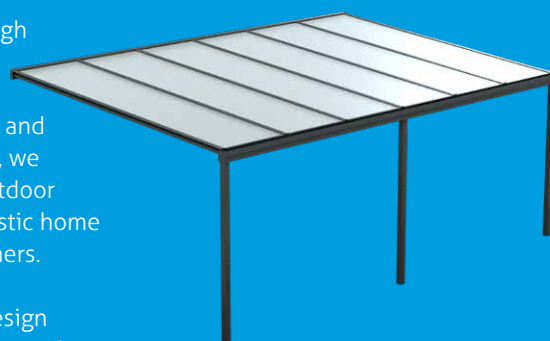
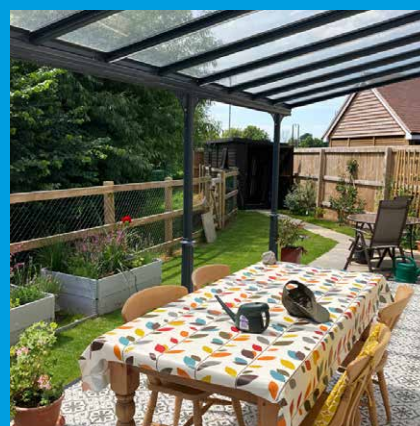



Simplicity 6 Veranda

Simplicity 6 is our most popular system. It offers a stylish veranda or canopy solution that is glazed with 6mm toughened glass.

Our most popular system, the Sim 6 offers a deluxe veranda or canopy at an affordable price due to its elegant posts and glass roofing options. By featuring the option of clear glass roofing, the Sim 6 offers improved acoustic properties – reducing the noise of rain drops during a downpour; these glass panels also provide a sparkling finish which is easy to maintain, particularly if the self-cleaning glass option is chosen.

The Simplicity 6 Glass Veranda is the perfect solution for domestic gardens and commercial properties, proving an effective and stylish cover from the weather for alfresco dining and garden parties.

With a span of up to 3.5m glass length from its supporting wall and unlimited length achievable, you will have a solution that can be adapted to suit your exact needs.

The Simplicity 6 comes with a full 10-year guarantee and a 60-year life expectancy, making this a cost-effective and reliable investment that you will be able to enjoy for many decades to come.

All framework is constructed from durable aluminium, with the option to powder coat the structure to RAL 7016 Anthracite Grey Textured, RAL 9016 White Semi Gloss, or RAL 9005 Jet Black Textured Finish.

Testimonial

“My neighbour likes the quality of the system so much that he’s considering ordering one himself in the New Year.”

DOMESTIC CUSTOMER

“Very pleased with the veranda, an excellent product and looks great!”

DOMESTIC CUSTOMER

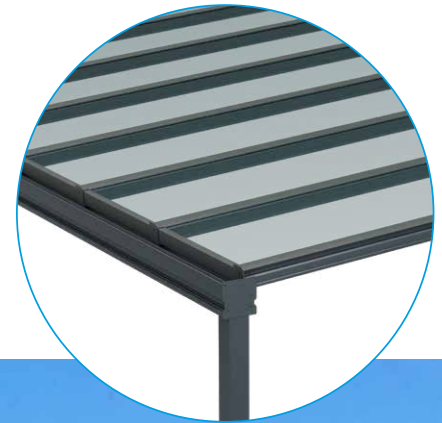

Features & Benefits

- **UV Activated Self-Cleaning Glass** – Optional 6mm self-cleaning toughened glass has a UV activated special coating that is applied during manufacture that breaks down organic dirt which is then washed away by the rain. Only a small amount of UV is needed to activate the special coating so that the veranda remains clean even on cloudy days
- **Toughened Glass** – Both glass options are toughened during manufacturing and achieve Class 1 BS EN 12600 for impact performance
- **Low Maintenance** – All roof options are low maintenance, particularly the self-cleaning glass, which means less cleaning is required, saving you time and money
- **High Light Transmittance** – All roof options offer high light transmittance
- **Available Projections** – Up to 3.5m projection (Bar length)
- **Simple Fixing System with Minimal Parts** – For a simple and speedy installation
- **Low Profile** – The Simplicity 6 can be fitted in height restricted areas
- **Integral Aluminium Guttering** – Creates a sleek, modern design which is stronger than external guttering systems and saves time on installation

Projection up to 3.5m

Posts Spacing

Projection: Up to 3.5m

Spacing: 3.0m (4m if using a Gutter Support Kit)

Glazing Bars Spacing

Projection: Up to 3.5m

Spacing: 600mm

Pitch

From 2.5 degrees to 22.5 degrees

These are general calculations, once we understand your requirements we will perform an assessment for wind and snow loadings based on your postcode.

Information on the design load and maximum span limits is available on request.



Optional Upgrades

The Simplicity 6 Veranda can be supplied with a host of upgrades to enhance the experience of using the area.

These include:

- **Victorian Upgrade Available** – Transform the contemporary Simplicity 6 into an ornate, traditional structure that fits in with older style buildings seamlessly.
- **Remote Controlled Integrated RGBW Lighting in the main bars** which will enable the area to be enjoyed in the evening.
- **Infrared Heaters** to make the area more comfortable on those chilly days and nights.
- **Fixed or Sliding Glass Side or Front Panels** to offer complete weather protection around the front or the sides.

Standard Colours

RAL COLOUR		FINISH
Anthracite Grey RAL 7016		Textured Only
Traffic White RAL 9016		Semi-Gloss
Jet Black RAL 9005		Textured Only

Options



VICTORIAN
UPGRADE



RGBW
LIGHTING IN
MAIN BARS



INFRARED
HEATERS
AVAILABLE



MULTIPLE
GLAZING
OPTIONS



70MM X 70MM
70MM X 75MM
70MM X 100MM
POST SIZES

Heating & Lighting

See pages 35-40 for more information on the heating and lighting upgrades.

Simplicity 16 Veranda

Unbeatable structural performance system that is quick and easy to install. Ideal for cost-effective Garden Verandas & Canopies.

It's simple, the Simplicity 16 has been developed with speed of installation, durability, and affordability in mind.

Due to its clever design, the Simplicity 16 provides a durable and attractive shade and shelter solution at our most cost-effective price. It can project up to 4 metres and has a lightweight roofing system, making it perfect for use as a veranda or canopy.

The stylish modern design gives a look that is second to none, enhancing your building's aesthetics. It also offers

unbeatable structural performance, simply outperforming all other veranda and canopy systems pound for pound.

The Simplicity 16 comes with a full 10-year guarantee and a 60-year life expectancy, offering a futureproof investment at our most cost-effective price.

The framework is completely manufactured from aluminium and can be powder coated in RAL 7016 Anthracite Grey, RAL 9016 White or RAL 9005 Jet Black all in a Textured Finish.

Testimonial

"Our veranda was carefully delivered and well packaged. It is now up in our finished garden, and we are delighted with it! It's great for shelter from the rain, as well as shade in summer. It gives our son a safe relaxing space to use his wheelchair in, and allows us to spend quality family time together. We would highly recommend!"

DOMESTIC CUSTOMER

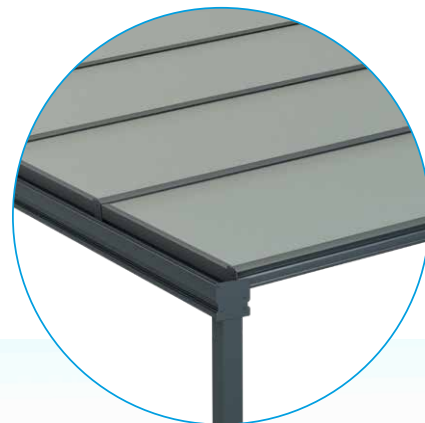

Features & Benefits

- **Available in any length**
- **Available Projections** – Available up to 4m projection depending on snow load
- **Simple fixing system with minimal parts** - For quick and easy installation
- **Low profile** – The Simplicity 16 can be fitted in areas where height is restricted
- **Stainless Steel Fixings** – All fixings are 316 marine grade stainless steel
- **Integral Aluminium Guttering** – Saves time on installation and is also stronger than an external gutter system.

- **16mm Structured Polycarbonate Panels** - Available in a clear, bronze, opal or Heatshield grey
- **High UV Protection** – A layer of UV absorber is co-extruded onto our roofing panels to offer high UV protection

Information on the design load and maximum span limits are available on request.



Projection up to 4m

Posts Spacing

Projection: Up to 4m

Spacing: 3.0m (4m if using a Gutter Support Kit)

Glazing Bars Spacing

Projection: Up to 3m 3.001m - 3.5m 4m

Spacing: 1m 700mm 500mm

Pitch

From 2.5 degrees to 22.5 degrees

These are general calculations, once we understand your requirements we will perform an assessment for wind and snow loadings based on your postcode.

Optional Upgrades

The Simplicity 16 can be supplied with upgrades as follows:

These include:

- **Victorian Upgrade Available** – Enhance the structure with traditional style decorative post sleeves and gallows brackets
- **Integrated RGBW Lighting Available in gutter only** – Lighting can be added to enable your customers to entertain when the sun goes down
- **Infrared Heaters Available** – Infrared Heaters can be added to the to your veranda to create a warm and cosy area underneath
- Benefit from a range of **polycarbonate roofing options** such as clear, bronze, opal or Heatshield grey

Standard Colours

RAL COLOUR		FINISH
Anthracite Grey RAL 7016		Textured Only
Traffic White RAL 9016		Semi-Gloss
Jet Black RAL 9005		Textured Only

Options



VICTORIAN
UPGRADE



RGBW
LIGHTING IN
GUTTER



INFRARED
HEATERS
AVAILABLE



MULTIPLE
POLY OPTIONS
AVAILABLE



70MM X 70MM
70MM X 75MM
70MM X 100MM
POST SIZES

Heating & Lighting

See pages 35-40 for more information on the heating and lighting upgrades.

Simplicity 35 Veranda

The Simplicity 35 is durable, versatile, and benefits from unlimited length making this the ideal solution for commercial properties and those domestic homeowners looking to cover a significant space.

It is completely constructed from aluminium, giving you a structure with unbeatable durability together with a life expectancy of up to 60 years. This robust system is also supplied with a full 10 year guarantee.

The Sim 35 can be manufactured to any length to meet specific requirements and can span up to 6 metres, enabling you to cover a larger space using a minimal number of posts.

It has a modern, stylish appearance and benefits from robust integral aluminium guttering which creates an attractive finish to the structure while also ensuring a quick installation.

Furthermore, this aluminium guttering requires minimal subsequent maintenance throughout the product's lifetime.

The Simplicity 35 system features 35mm structured polycarbonate roof panels, which are available in clear, opal, bronze, or Heatshield Grey and offers in excess of 98% UV protection.

The Simplicity 35 has a variable wall pitch so you can decide on the height of the wall-plate to suit your needs. The aluminium framework is supplied in Anthracite Grey Textured (RAL 7016) and White Textured (RAL 9016) as standard.

Testimonial

"I researched the quality of several other suppliers, and none matched the quality of their product. From order to installation the process was faultless, It was reassuring to know that if help was needed, a phone call quickly sorted it. Highly recommended."

DOMESTIC CUSTOMER



Features & Benefits

- **Fully Aluminium System** – Including heavy duty structural aluminium roof bars for ultimate strength
- **Stainless Steel Fixings** – All of the fixings are stainless steel for longevity and total resistance to corrosion
- **Integral Aluminium Guttering** – Saves time on installation and creates a robust and attractive gutter system
- **35mm Structured Polycarbonate Panels** - Our 7 wall polycarbonate is amongst the strongest you can buy.
- **Fire Performance** - Polycarbonate panels benefit from excellent fire performance, meeting BS476 part 7 class 1, EN13501 and B-s1, d0
- **Robust Roof System** – The roofing system is strong enough to be walked on as a means of escape and maintenance, with the use of boards (edge protection recommended)
- **High UV Protection** – A layer of UV absorber is co-extruded on the outer surface of the roof panels which prevents damaging UV radiation from penetrating the sheet and protects those underneath from the sun. UV protection also prevents yellowing and loss of strength to the panel, giving it longer life
- **Variable Roof Pitch** – The roof has a variable pitch of between 2.5° – 45°
- **Large Projection** – Projection of up to 6 metres to create large shaded areas if required
- **Unlimited Length** – This structure can be constructed to any length to suit requirements.

Projection up to 6m

Posts Spacing

Projection:	Up to 4m	4.1m - 6m
Spacing:	3.5m	3m

Glazing Bars Spacing

Projection:	Up to 4.5m	4.5m - 5.3m	5.301 - 6m
Spacing:	1250mm	700mm	500mm

Pitch

From 2.5 degrees to 45 degrees

These are general calculations, once we understand your requirements we will perform an assessment for wind and snow loadings based on your postcode.

Information on the design load and maximum span limits is available on request.



Optional Upgrades

The Simplicity 35 comes with a host of upgrades to enhance the area.

These include:

- **Victorian Upgrade Available** – Transform the Simplicity 35 into a decorative structure with the Victorian Upgrade
- **Infrared Heaters Available** – Add Infrared Heaters to your veranda to create a warm and cosy area underneath when socialising or dining outside in your garden
- **Integrated RGBW Lighting Available in the main bars** – Optional lighting to your veranda to enable you to entertain when the sun goes down
- Benefit from a range of **polycarbonate roofing options** such as clear, bronze, opal or Heatshield grey

Standard Colours

RAL COLOUR	FINISH
Anthracite Grey RAL 7016 	Textured Only
Traffic White RAL 9016 	Textured Only

Options



VICTORIAN
UPGRADE



RGBW
LIGHTING IN
GUTTER



INFRARED
HEATERS
AVAILABLE



MULTIPLE
POLY OPTIONS
AVAILABLE



80MM X 80MM
POST SIZE

Heating & Lighting

See pages 35-40 for more information on the heating and lighting upgrades.

Simplicity Xtra Veranda

Enhance your outdoor living experience with a Simplicity Xtra Glass Room, whether you enjoy entertaining, dining, or simply relaxing in your garden. The versatility of a Simplicity Xtra Glass Room will provide that lifestyle.

This Simplicity Xtra is stunning veranda which gives you the ultimate outdoor living solution for those areas with 4m projection.

In order support this incredible structure, the post dimensions are 70mm x 100mm giving this system a solid contemporary look, allowing it cover large surface areas with minimal posting.

The Simplicity Xtra is supplied with a full 10-year guarantee and a 60-year life expectancy for the veranda or canopy frame.

The framework is completely manufactured from aluminium and



can be powder coated in a Textured RAL 7016 Anthracite Grey or RAL 9005 Jet Black finish. It also features 6mm toughened glass that is available in a range of tinted options.

Testimonial

"Thank you very much for all your help we are very pleased with the way this has been handled and the price, we will be sure to highly recommend your company. We are exceptionally pleased with the whole thing. We've never had anything like this done before but the system has fitted it in wonderfully. Once again thank you to you and your team."

COMMERCIAL CUSTOMER

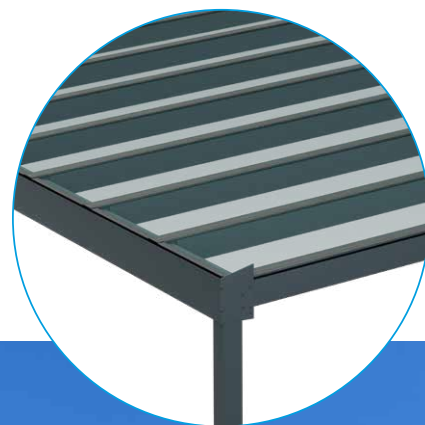

Features & Benefits

- **UV Activated Self-Cleaning Glass** – Optional 6mm self-cleaning toughened glass has a UV activated special coating that is applied during manufacture that breaks down organic dirt which is then washed away by the rain. Only a small amount of UV is needed to activate the special coating so that the veranda remains clean even on cloudy days
- **Toughened Glass** – Both glass options are toughened during manufacturing and achieve Class 1 BS EN 12600 for impact performance
- **Low Maintenance** – All roof options are low maintenance, particularly the self-cleaning glass, which means less cleaning is required, saving you time and money
- **High Light Transmittance** – All roof options offer high light transmittance
- **Available Projections** – Up to 4m projection (Bar length)
- **Simple Fixing System with Minimal Parts** – For a simple and speedy installation
- **Low Profile** – The Simplicity Xtra can be fitted in height restricted areas
- **Integral Aluminium Guttering** – Creates a sleek, modern design which is stronger than external guttering systems and saves time on installation

Projection up to 4m

Posts Spacing

Projection: Up to 4m

Spacing: 4.0m

Glazing Bars Spacing

Projection: Up to 4m

Spacing: 600mm

Pitch

From 2.5 degrees to 22.5 degrees

These are general calculations, once we understand your requirements we will perform an assessment for wind and snow loadings based on your postcode.

Information on the design load and maximum span limits is available on request.



Optional Upgrades

The Simplicity Xtra Glass Veranda can be supplied with a host of upgrades to enhance the experience of using the area.

These include:

- **Victorian Upgrade Available** – Transform the contemporary Simplicity Xtra into an ornate, traditional structure that fits in with older style buildings seamlessly.
- **Spotlights Available** – Spotlights that are mounted within the Bolster bar.
- **Wall Mounted Heaters** – Add wall mounted heaters to make your customers' glass rooms more comfortable on those chilly days and evenings.

Standard Colours

RAL COLOUR	FINISH
Anthracite Grey RAL 7016 	Textured Only
Jet Black RAL 9005 	Textured Only

Options



VICTORIAN
UPGRADE



LED
SPOTLIGHTS
ONLY



INFRARED
HEATERS
AVAILABLE



70MM X 70MM
70MM X 75MM
70MM X 100MM
POST SIZES

Heating & Lighting

See pages 35-40 for more information on the heating and lighting upgrades.

Simplicity Free Veranda

An innovative and versatile system that delivers stunning contemporary aesthetics. Ideal for use as wall-mounted or free-standing veranda or garden room.

The Simplicity Free system has been created with contemporary design, flawless functionality, and ease-of-installation in mind. Named for its free-standing option, the Simplicity Free delivers maximum versatility to homeowners.

This truly modern structure features a quick-fit, top-fix/snap-down glazing solution to speed up the installation of the 6mm toughened glass.

With a maximum projection of 4 metres and any desired length achievable, the Simplicity Free is perfect for any veranda patio area.

Constructed from aluminium and designed with the rigours of the UK weather in mind, the Simplicity Free has a sturdy 8-millimetre galvanised steel profile corner connector plate to guarantee firm installation. Engineered to last, the Sim Free has an expected lifespan of 60 years and comes with a 10-year guarantee.

Testimonial

"We have recently had our Glass Room installed and early signs show great potential. We're excited to use our new sheltered space particularly when we have the family round in the summer!"

DOMESTIC CUSTOMER

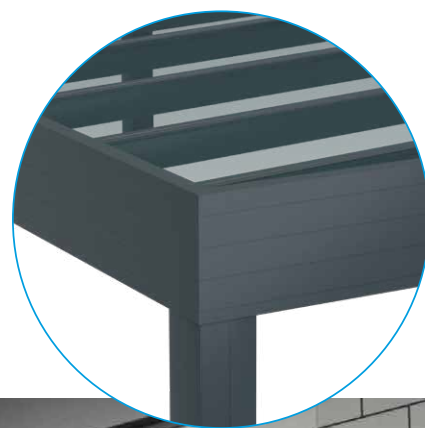

Features & Benefits

- **Wall Mounted or Free Standing Options** - The Sim Free is able to be installed fixed to the house or as an independent, free-standing structure
- **Clean Contemporary Cubic Design** - We have carefully designed the Sim Free to deliver an absolutely stunning visual impact
- **Quick-Fit, top-fix/snap-down glazing system** - The glass panels are quickly and easily fixed into place with a quick-fit system
- **Sturdy 8mm galvanised steel profile connector plate** - Internal corner connections are made with strong steel plate for firm installation
- **Integrated gutters and downpipes** - Water management is effortlessly achieved with the Sim Free, with rainwater evacuated via hidden, internal drainage
- **Roof bars with optional integrated Somfy-controlled LED lights** - Lighting is available, with LED spotlights in the roof bars
- **6mm toughened glass** - Available in clear or coloured options, the roof glass panels are highly strong and provide shade and shelter
- **4 metre maximum projection, 4 metre maximum between posts, any length achievable** - Highly versatile installation options, able to provide a large footprint for the largest patios
- **3m Maximum post height** - The Sim Free can provide a very high clearance, ideal for large properties or commercial and public spaces
- **Chunky 30 centimetre Ring Beam around perimeter** - Very strong, visually sleek and modern with hidden fixings and gutter, the Sim Free Ring Beam is a contemporary and practical solution

Projection up to 4m

Posts Spacing

Height: Up to 3m

Spacing: Up to 4.0m

Glazing Bars Spacing

Projection: 4m

Spacing: 600mm

Pitch

Fixed Pitch, hidden from view by flat Ring Beam.

- **Surface mounted or Cast-in Post Options** - Versatile fixing to the ground, with the option to mount beneath ground or securely mount to the floor surface if penetration is not feasible

Information on the design load and maximum span limits is available on request.



Optional Upgrades

The Simplicity Free comes with a host of upgrades to enhance the area.

These include:

- **Sliding Glass Doors and Fixed Glass Panel Upgrade** - Enjoy truly outdoor living by creating an enclosed glass room
- **Infrared Heaters Available** - Add Infrared Heaters to your veranda to create a warm and cosy area underneath when socialising or dining outside in your garden
- **Spotlights Available** - Spotlights that are mounted within the Bolster bar.

Standard Colours

RAL COLOUR	FINISH
Anthracite Grey RAL 7016 	Textured Only
Jet Black RAL 9005 	Textured Only

Options



LED SPOTLIGHTS ONLY



INFRARED HEATERS AVAILABLE



MULTIPLE GLAZING OPTIONS



150MM x 150MM POST AVAILABLE

Heating & Lighting

See pages 35-40 for more information on the heating and lighting upgrades.

Alfresco Contemporary Veranda

The Alfresco Contemporary has the option to span a massive 6 metres from post to post allowing for wide and uncompromised panoramic views.

Inspired through work with a leading designer with the aim of creating an innovative and truly stunning system, the Alfresco Contemporary will enhance and bring additional value to your home. Creating a sheltered and comfortable outdoor living space in your garden or commercial property regardless of the weather.

The roof can be covered with a choice of 8mm toughened glass that offers a clear view of the sky. Hidden within the frame is integrated guttering and downpipes keeping the appearance of this structure smart and sharp.

Made completely from aluminium for ultimate longevity, they feature easy-fix clips on profiles that hide fixings and downpipes from view, offering a stylish and modern look. This also means that any cabling for additional extras such as lighting, heating or even a sound system can be hidden from view with no unsightly trailing cables.

The Alfresco is supplied with a 10 year guarantee and a minimum 60 year life expectancy and many optional extras.

Testimonial

"I needed a shelter for the patio space in my garden and stumbled across the Alfresco Contemporary while researching the market. The design ticked all the boxes I was looking for and I can't thank the team enough for a quick and hassle-free installation."

DOMESTIC CUSTOMER

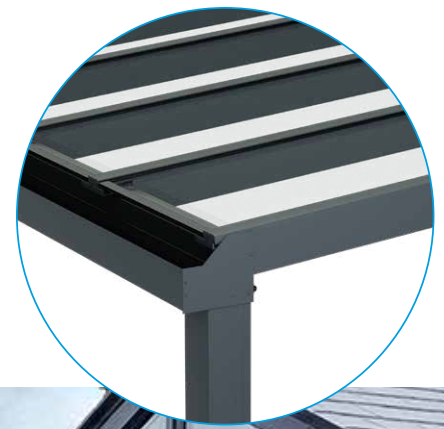

Features & Benefits

- **Full 10 Year Guarantee** – The Alfresco Range is supplied with a full 10 year guarantee and a minimum 60 year life expectancy for the canopy frame
- **Choice of Glass** – 8mm Toughened Glass in clear, grey or bronze
- **Low Maintenance** – All systems are aluminium so maintenance is significantly reduced over other PVC options available elsewhere on the market
- **Available Projections** – Up to an impressive 6 metres
- **Integral Aluminium Guttering and Easy-Fix profiles** – Creates a sleek, modern design.

Information on the design load and maximum span limits is available on request.

Projection up to 6m

Posts Spacing

Projection: Up to 6m

Spacing: 6.0m

Glazing Bars Spacing

Projection: Up to 6m

Spacing: 800mm

Pitch

5 degrees minimum to 45 degrees maximum

These are general calculations, once we understand your requirements we will perform an assessment for wind and snow loadings based on your postcode.



Optional Upgrades

The Alfresco Contemporary can be supplied with a host of upgrades to enhance the experience of using the area.

These include:

- **Integrated RGBW Lighting Available** in the main bars – Optional lighting to your veranda to enable you to entertain when the sun goes down
- **Infrared Heaters** to make the area more comfortable on those chilly days and nights.
- **Fixed or Sliding Glass Side or Front Panels** to offer complete weather protection around the front or the sides.

Standard Colours

RAL COLOUR	FINISH
Anthracite Grey RAL 7016 	Textured Only

Options



GLASS ROOM AVAILABLE



RGBW LIGHTING IN MAIN BARS



INFRARED HEATERS AVAILABLE



150MM X 150MM POST AVAILABLE

Heating & Lighting

See pages 35-40 for more information on the heating and lighting upgrades.

Glass Rooms

Glass rooms allow you to bring the beauty of the outdoors into your home with their style, design, and versatility. With these unique designs, we can offer a system that will both fit the appearance and function that you're looking for at an affordable and cost-effective price.

Whether you choose retractable glass sliding doors or fixed glass panels, your home will be open to the great outdoors while offering panoramic views. In addition, it will protect the interior which will be free from the elements. It is therefore possible to enjoy outdoor living from the comfort of your home.

Any home will benefit from a glass room that allows people to be outside all year round.

Each system is individually designed and manufactured to reflect your aspirations and requirements, as well as maximising the space available. A glass room will also add value to your property, with complementary style and character regardless of where you may be situated within the UK.

All glass rooms in this brochure are constructed from extruded aluminium profiles and powder-coated to the desired RAL colour code. RAL 7016 Anthracite Grey, RAL 9016 White and RAL 9005 Jet Black are all available as standard in a Textured Finish, with bespoke colours available for an additional fee.

The glass room ceilings contain toughened glass roof panels that provide a robust finish with multiple options available such as clear, self-cleaning, and tinted, subject to availability.

We provide optional heating and lighting solutions that will enhance your outdoor living space, transforming it into an area that can be used into the evening in all seasons.

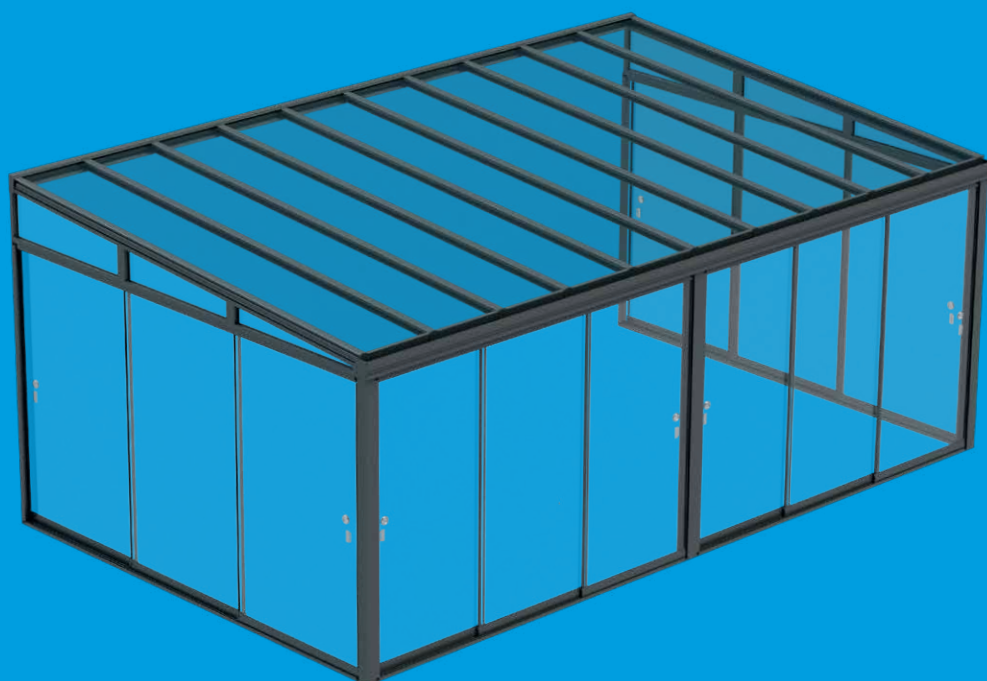



Simplicity 6 Glass Room

The perfect way to make the most of your outdoor space. You'll have endless opportunities at your fingertips from hosting events to relaxing in an outdoor living space free from the elements. The versatility of a Simplicity 6 Glass Room adds a whole new level to your lifestyle.

The Simplicity 6 model is a proven and effective system, and the most popular system within our range. The addition of retractable glass sliding doors and fixed panels to such a stylish glass veranda creates an outdoor room that's weather-proof and usable all year long.

With optional heating and lighting upgrades, the Simplicity 6 Glass Room is the perfect addition to any domestic garden or commercial property. As a result of all the features, benefits, and affordability of such a popular glass room system, you'll be able to add value and potential to your home.

The framework is completely manufactured from aluminium and can be powder coated in RAL 7016 Anthracite Grey, RAL 9016 White or RAL 9005 Jet Black all in a Textured Finish. It also features 6mm toughened glass that is available in self-cleaning a range of tinted options.

Please note that our systems are not thermally broken and therefore they may require heating or ventilation solutions if they are specified to be fully enclosed.

Testimonial

"Due to the limited patio space we had, it was a struggle to find a product which didn't take up a lot of space but would give us a sheltered area that we could enjoy the garden in all year round. The Simplicity 6 Glass Room met our needs perfectly and we find ourselves in it most days thanks to the heaters and lighting that we opted for."

DOMESTIC CUSTOMER



Features & Benefits

- **UV Activated Self-Cleaning Glass** – Optional 6mm self-cleaning toughened glass has a UV activated special coating that is applied during manufacture that breaks down organic dirt which is then washed away by the rain. Only a small amount of UV is needed to activate the special coating so that the veranda remains clean even on cloudy days
- **Toughened Glass** – Both glass options are toughened during manufacturing and achieve Class 1 BS EN 12600 for impact performance
- **Low Maintenance** – All roof options are low maintenance, particularly the self-cleaning glass, which means less cleaning is required, saving you time and money
- **High Light Transmittance** – All roof options offer high light transmittance
- **Available Projections** – Up to 3.5m projection (Bar length)
- **Simple Fixing System with Minimal Parts** – For a simple and speedy installation
- **Low Profile** – The Simplicity 6 can be fitted in height restricted areas
- **Integral Aluminium Guttering** – Creates a sleek, modern design which is stronger than external guttering systems and saves time on installation

Projection up to 3.5m

Posts Spacing

Projection: Up to 3.5m

Spacing: 3.0m

Glazing Bars Spacing

Projection: Up to 3.5m

Spacing: 600mm

Pitch

From 2.5 degrees to 22.5 degrees

These are general calculations, once we understand your requirements we will perform an assessment for wind and snow loadings based on your postcode.

Information on the design load and maximum span limits is available on request.



Optional Upgrades

The Simplicity 6 Glass Room can be supplied with a host of upgrades to enhance the experience of using the area.

These include:

- **Victorian Upgrade Available** – Transform the contemporary Simplicity 6 into an ornate, traditional structure that fits in with older style buildings seamlessly.
- **Remote Controlled Integrated RGBW Lighting** which will enable the area to be enjoyed in the evening.
- **Infrared Heaters** to make the area more comfortable on those chilly days and nights.
- **Fixed or Sliding Glass Side or Front Panels** to offer complete weather protection around the front or the sides.

Standard Colours

RAL COLOUR		FINISH
Anthracite Grey RAL 7016		Textured Only
Traffic White RAL 9016		Semi-Gloss
Jet Black RAL 9005		Textured Only

Options



VICTORIAN
UPGRADE



RGBW
LIGHTING IN
MAIN BARS



INFRARED
HEATERS
AVAILABLE



MULTIPLE
GLAZING
OPTIONS



70MM X 70MM
70MM X 75MM
70MM X 100MM
POST SIZES

Heating & Lighting

See pages 35-40 for more information on the heating and lighting upgrades.

Simplicity 16 Glass Room

Looking for additional protection and a stylish way to maximise your new Simplicity 16 Veranda? The optional Glass Room upgrade will allow you to create just that.

The modern design gives your building an aesthetic that is unparalleled. Furthermore, pound-for-pound, it is unmatched in structural performance, outperforming every other veranda and canopy system.

Glass retractable sliding doors and fixed glass panels offer uninterrupted panoramic views of the surrounding garden. They also protect those within the structure from the elements, extending the 'outdoor living experience' into the comfort of your home. A glass room allows users to enjoy the great outdoors all year round and will become the heart of any home.

The stylish modern design gives a look that is second to none, enhancing your building's aesthetics.

The framework is completely manufactured from aluminium and can be powder coated in RAL 7016 Anthracite Grey, RAL 9016 White or RAL 9005 Jet Black all in a Textured Finish.

Please note that our systems are not thermally broken and therefore they may require heating or ventilation solutions if they are specified to be fully enclosed.

Testimonial

"We opted for a Sim 16 Glass Room as we were very price conscious when searching the market. We hoped to find a system that provided additional living space while offering protection all year round, both in the sunnier climates and the cold and wet days too."

COMMERCIAL CUSTOMER

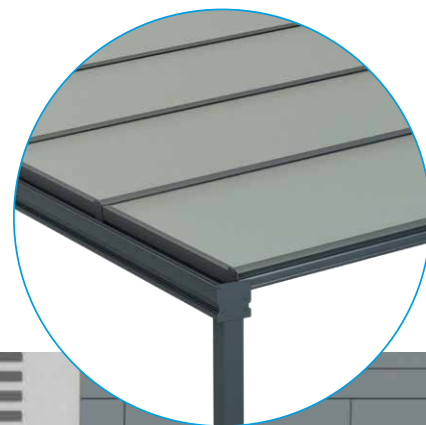

Features & Benefits

- **Simple fixing system with minimal parts** - For quick and easy installation
- **Available in any length**
- **Available Projections** – Available up to 4m projection depending on snow load
- **Low profile** – The Simplicity 16 can be fitted in areas where height is restricted
- **Stainless Steel Fixings** – All fixings are 316 marine grade stainless steel
- **Integral Aluminium Guttering** – Saves time on installation and is also stronger than an external gutter system.

- **16mm Structured Polycarbonate Panels** - Available in a clear, bronze, opal or Heatshield grey
- **High UV Protection** – A layer of UV absorber is co-extruded onto our roofing panels to offer high UV protection

Information on the design load and maximum span limits are available on request.



Projection up to 4m

Posts Spacing

Projection: Up to 4m

Spacing: 3m

Glazing Bars Spacing

Projection: Up to 3m 3.001m - 3.5m 4m

Spacing: 1m 700mm 500mm

Pitch

From 2.5 degrees to 22.5 degrees

These are general calculations, once we understand your requirements we will perform an assessment for wind and snow loadings based on your postcode.



Optional Upgrades

The Simplicity 16 Glass Room can be supplied with upgrades as follows:

These include:

- **Victorian Upgrade Available** – Enhance the structure with traditional style decorative post sleeves and gallows brackets
- **Integrated RGBW Lighting Available in gutter only** – Lighting can be added to enable your customers to entertain when the sun goes down
- **Infrared Heaters Available** – Infrared Heaters can be added to the to your veranda to create a warm and cosy area underneath
- Benefit from a range of **polycarbonate roofing options** such as clear, bronze, opal or Heatshield grey

Standard Colours

RAL COLOUR		FINISH
Anthracite Grey RAL 7016		Textured Only
Traffic White RAL 9016		Semi-Gloss
Jet Black RAL 9005		Textured Only

Options



VICTORIAN
UPGRADE



RGBW
LIGHTING IN
GUTTER



INFRARED
HEATERS
AVAILABLE



MULTIPLE
POLY OPTIONS
AVAILABLE



70MM X 70MM
70MM X 75MM
70MM X 100MM
POST SIZES

Heating & Lighting

See pages 35-40 for more information on the heating and lighting upgrades.

Simplicity 35 Glass Room

The Simplicity 35 is durable, versatile, and benefits from unlimited length.

It is completely constructed from aluminium, giving you a structure with unbeatable durability that is built to last. You'll have full peace of mind that your outdoor living solution is entirely futureproof.

The Simplicity 35 can be manufactured to any length to meet specific requirements and can span up to 6 metres, enabling you to cover a larger space using a minimal number of posts.

It has a modern, stylish appearance and benefits from robust integral aluminium guttering which creates an attractive finish to the structure while also ensuring a quick installation. Furthermore, this aluminium guttering requires minimal subsequent

maintenance beyond simple cleaning throughout the product's lifetime.

The Simplicity 35 system features 35mm structured polycarbonate roof panels, which are available in clear, opal, or heat-guard and offers more than 98% UV protection.

The Simplicity 35 has a variable wall pitch so you can decide on the height of the wall-plate to suit your needs. The aluminium framework is supplied in Anthracite Grey Textured (RAL 7016) or White Textured (RAL 9016) as standard.

Please note that our systems are not thermally broken and therefore they may require heating or ventilation solutions if they are specified to be fully enclosed.

Testimonial

"A great addition to our home, this Glass Room offers a wide variety of usage such as storage in the winter month and a great outdoor space that we can open up in the sunnier months. A great investment and we could not be more pleased."

DOMESTIC CUSTOMER



Features & Benefits

- **Fully Aluminium System** – Including heavy duty structural aluminium roof bars for ultimate strength
- **Stainless Steel Fixings** – All of the fixings are stainless steel for longevity and total resistance to corrosion
- **Integral Aluminium Guttering** – Saves time on installation and creates a robust and attractive gutter system
- **35mm Structured Polycarbonate Panels** - Our 7 wall polycarbonate is amongst the strongest you can buy.
- **Fire Performance** - Polycarbonate panels benefit from excellent fire performance, meeting BS476 part 7 class 1, EN13501 and B-s1, d0
- **Robust Roof System** – The roofing system is strong enough to be walked on as a means of escape and maintenance, with the use of boards (edge protection recommended)
- **High UV Protection** – A layer of UV absorber is co-extruded on the outer surface of the roof panels which prevents damaging UV radiation from penetrating the sheet and protects those underneath from the sun. UV protection also prevents yellowing and loss of strength to the panel, giving it longer life
- **Variable Roof Pitch** – The roof has a variable pitch of between 2.5° – 45°
- **Large Projection** – Projection of up to 6 metres to create large shaded areas if required
- **Unlimited Length** – This structure can be constructed to any length to suit requirements.

Projection up to 6m

Posts Spacing

Projection:	Up to 4m	4.1m - 6m
Spacing:	3.5m	3m

Glazing Bars Spacing

Projection:	Up to 4.5m	4.5m - 5.3m	5.301 - 6m
Spacing:	1250mm	700mm	500mm

Pitch

From 2.5 degrees to 45 degrees

These are general calculations, once we understand your requirements we will perform an assessment for wind and snow loadings based on your postcode.

Information on the design load and maximum span limits is available on request.



Optional Upgrades

The Simplicity 35 Glass Room comes with a host of upgrades to enhance the area.

These include:

- **Victorian Upgrade Available** – Transform the Simplicity 35 into a decorative structure with the Victorian Upgrade
- **Infrared Heaters Available** – Add Infrared Heaters to your veranda to create a warm and cosy area underneath when socialising or dining outside in your garden
- **Integrated RGBW Lighting Available in the main bars** – Optional lighting to your veranda to enable you to entertain when the sun goes down
- Benefit from a range of **polycarbonate roofing options** such as clear, bronze, opal or Heatshield grey

Standard Colours

RAL COLOUR	FINISH
Anthracite Grey RAL 7016 	Textured Only
Traffic White RAL 9016 	Textured Only

Options



VICTORIAN
UPGRADE



RGBW
LIGHTING IN
GUTTER



INFRARED
HEATERS
AVAILABLE



MULTIPLE
POLY OPTIONS
AVAILABLE



80MM X 80MM
POST SIZE

Heating & Lighting

See pages 35-40 for more information on the heating and lighting upgrades.

Simplicity Xtra Glass Room

The Simplicity Xtra Glass Room is both flexible and stylish, capable of seamlessly integrating into properties that are both traditional and modern. Homeowners with a Simplicity Xtra will benefit from year-round protection at an affordable and cost-effective price as the Simplicity Xtra is our entry level Glass Room.

Homeowners can benefit by incorporating retractable glass sliding doors and fixed panels to our Simplicity Xtra model to create an outdoor living solution that is not only weather protected for use all year round, but a range of optional upgrades to enhance the overall functionality.

As a result of its optional heating and lighting features, the Simplicity Xtra Glass Room is the perfect choice for domestic gardens and commercial spaces. With all the features, benefits, and style of currently available glass room systems, this is a great option

available at a cost-effective price and high quality.

The frame is entirely made of aluminium and powder coated in the extremely popular RAL 7016 Anthracite Grey or RAL 9005 Jet Black (Textured). A range of tinted glass options is also available in 6mm toughened glass.

Please note that our systems are not thermally broken and therefore they may require heating or ventilation solutions if they are specified to be fully enclosed.

Testimonial

"Our old veranda had vertical awnings on the sides and whilst this was great for shade protection, it wasn't good in the wind. We wanted a solution where we could have the best of both worlds and now have this with our glass room. We like the sleek design of the system and the large span between the posts. A great addition to our home."

DOMESTIC CUSTOMER

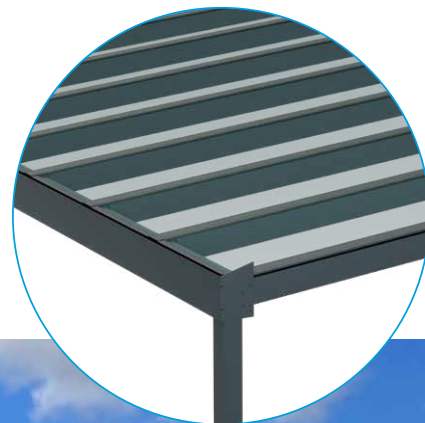

Features & Benefits

- **UV Activated Self-Cleaning Glass** – Optional 6mm self-cleaning toughened glass has a UV activated special coating that is applied during manufacture that breaks down organic dirt which is then washed away by the rain. Only a small amount of UV is needed to activate the special coating so that the veranda remains clean even on cloudy days
- **Toughened Glass** – Both glass options are toughened during manufacturing and achieve Class 1 BS EN 12600 for impact performance
- **Low Maintenance** – All roof options are low maintenance, particularly the self-cleaning glass, which means less cleaning is required, saving you time and money
- **High Light Transmittance** – All roof options offer high light transmittance
- **Available Projections** – Up to 4m projection (Bar length)
- **Simple Fixing System with Minimal Parts** – For a simple and speedy installation
- **Low Profile** – The Simplicity Xtra can be fitted in height restricted areas
- **Integral Aluminium Guttering** – Creates a sleek, modern design which is stronger than external guttering systems and saves time on installation

Information on the design load and maximum span limits is available on request.

Projection up to 4m

Posts Spacing

Projection: Up to 4m

Spacing: 4.0m

Glazing Bars Spacing

Projection: Up to 4m

Spacing: 600mm

Pitch

From 2.5 degrees to 22.5 degrees

These are general calculations, once we understand your requirements we will perform an assessment for wind and snow loadings based on your postcode.



Optional Upgrades

The Simplicity Xtra Glass Room can be supplied with a host of upgrades to enhance the experience of using the area.

These include:

- **Victorian Upgrade Available** – Transform the contemporary Simplicity Xtra into an ornate, traditional structure that fits in with older style buildings seamlessly.
- **Spotlights Available** – Spotlights that are mounted within the Bolster bar.
- **Wall Mounted Heaters** – Add wall mounted heaters to make your customers' glass rooms more comfortable on those chilly days and evenings.

Standard Colours

RAL COLOUR	FINISH
Anthracite Grey RAL 7016 	Textured Only
Jet Black RAL 9005 	Textured Only

Options



VICTORIAN
UPGRADE



LED
SPOTLIGHTS
ONLY



INFRARED
HEATERS
AVAILABLE



70MM X 70MM
70MM X 75MM
70MM X 100MM
POST SIZE

Heating & Lighting

See pages 35-40 for more information on the heating and lighting upgrades.

Simplicity Free Glass Room

A stunning contemporary aesthetic is delivered by this innovative and versatile system. The Simplicity Free is our premium free-standing or wall-mounted Glass Room option.

Designed to blend contemporary design with flawless functionality, Simplicity Free offers easy installation. Homeowners have the option of choosing a free-standing Sim Free model, which offers maximum versatility.

The 6mm toughened glass is installed quickly and easily with a quick-fit, top-fix/snap-down glazing system.

Any garden patio in need of a veranda or canopy can benefit from the Simplicity Free. The maximum projection is 4 metres, and any desired length can be achieved.

In addition to its aluminium construction and galvanised steel

corners, the Simplicity Free corners are designed to withstand the rigorous UK weather. This product has been engineered to last 60 years and includes a 10-year guarantee.

Please note that our systems are not thermally broken and therefore they may require heating or ventilation solutions if they are specified to be fully enclosed.



Testimonial

"We ordered a Simplicity Glass Room to create a new outdoor space at the bottom of our garden. We enjoy spending time outdoors but with the UK weather as unpredictable as it can be, it's nice to know that we have added protection from wind and rain."

DOMESTIC CUSTOMER

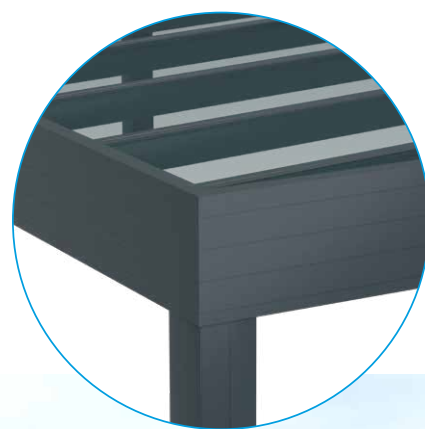

Features & Benefits

- **Wall Mounted or Free Standing Options** - The Sim Free is able to be installed fixed to the house or as an independent, free-standing structure
- **Clean Contemporary Cubic Design** – We have carefully designed the Sim Free to deliver an absolutely stunning visual impact
- **Quick-Fit, Top-fix/snap-down glazing system** – The glass panels are quickly and easily fixed into place with a quick-fit system
- **Sturdy 8mm galvanised steel profile connector plate** – Internal corner connections are made with strong steel plate for firm installation
- **Integrated gutters and downpipes** – Water management is effortlessly achieved with the Sim Free, with rainwater evacuated via hidden, internal drainage
- **Roof bars with optional integrated Somfy-controlled LED lights** – Lighting is available, with LED spotlights in the roof bars
- **6mm toughened glass** – Available in clear or coloured options, the roof glass panels are highly strong and provide shade and shelter
- **4 metre max projection, 4 metre max between posts, any length achievable** – Highly versatile installation options, able to provide a large footprint for the largest patios
- **3m Maximum post height** – The Sim Free can provide a very high clearance, ideal for large properties or commercial and public spaces
- **Chunky 30 centimetre Ring Beam around perimeter** – Very strong, visually sleek and modern with hidden fixings and gutter, the Sim Free Ring Beam is a contemporary and practical solution

Projection up to 4m

Posts Spacing

Height: Up to 3m

Spacing: Up to 4.0m

Glazing Bars Spacing

Projection: 4m

Spacing: 600mm

Pitch

Fixed Pitch, hidden from view by flat Ring Beam.

- **Surface mounted or Cast-in Post Options** – Versatile fixing to the ground, with the option to mount beneath ground or securely mount to the floor surface if penetration is not feasible

Information on the design load and maximum span limits is available on request.



Optional Upgrades

The Simplicity Free Glass Room comes with a host of upgrades to enhance the area.

These include:

- **Sliding Glass Doors and Fixed Glass Panel Upgrade** – Enjoy truly outdoor living by creating an enclosed glass room
- **Infrared Heaters Available** – Add Infrared Heaters to your veranda to create a warm and cosy area underneath when socialising or dining outside in your garden
- **Integrated LED Spot Lighting Available** – Spotlights that are mounted within the Bolster bar

Standard Colours

RAL COLOUR		FINISH
Anthracite Grey RAL 7016		Textured Only
Jet Black RAL 9005		Textured Only

Options



LED SPOTLIGHTS ONLY



INFRARED HEATERS AVAILABLE



ROOF PANEL COLOUR OPTIONS



150MM x 150MM SQUARE POST AVAILABLE

Heating & Lighting

See pages 35-40 for more information on the heating and lighting upgrades.

Alfresco Contemporary Glass Room

This uniquely designed Glass Room, like all of our solutions, comes with everything you need to complete your dream outdoor living solution and will offer both style and elegance to any property.

When incorporating Glass Sliding Doors or Glass Infill Panels, all year-round weather protection will be provided allowing you to enjoy your outdoor living experience.

The Contemporary Glass Room will become the focal point of any home, permitting you to plan for outdoor entertainment or outdoor dining without fear of any disruption from the UK variable weather.

The contemporary design can be further enhanced with the introduction of integrated LED lighting which can change the mood and ambience of the

alfresco living experience. The further addition of heaters will also offer greater functionality on those chilly evenings.

With a massive 6m span between posts, the panoramic views of the surroundings are completely uncompromised.

Please note that our systems are not thermally broken and therefore they may require heating or ventilation solutions if they are specified to be fully enclosed.

Testimonial

"Having updated all of our windows and created an area for bi-folding doors, we were looking for a veranda to let us use the garden area all year round and bring the outside in. We didn't want a traditional looking veranda so when we saw the Contemporary Alfresco, it suited the house perfectly.

Having an unimpaird view from the bi-folding doors was really important and the 6m post span is perfect. We use the space for entertaining in the summer months but as we are quite near the coast, protection from the wind was important. The sliding doors work so well and maintain the uninterrupted view of the garden and coastline."

DOMESTIC CUSTOMER



Features & Benefits

- **Full 10 Year Guarantee** – The Alfresco Range is supplied with a full 10 year guarantee and a minimum 60 year life expectancy for the canopy frame
- **Choice of Glass** – 8mm Toughened Glass in Clear/Grey or Bronze
- **Low Maintenance** – All systems are aluminium so maintenance is significantly reduced over other PVC options available elsewhere on the market
- **Available Projections** – Up to an impressive 6 metres
- **Integral Aluminium Guttering and Easy-Fix profiles** – Creates a sleek, modern design.

Information on the design load and maximum span limits is available on request.

Projection up to 6m

Posts Spacing

Projection: Up to 6m

Spacing: 6.0m

Glazing Bars Spacing

Projection: Up to 6m

Spacing: 800mm

Pitch

5 degrees minimum to 45 degrees maximum

These are general calculations, once we understand your requirements we will perform an assessment for wind and snow loadings based on your postcode.



Optional Upgrades

The Alfresco Contemporary Glass Room can be supplied with a host of upgrades to enhance the experience of using the area.

These include:

- **Integrated RGBW Lighting Available** in the main bars – Optional lighting to your veranda to enable you to entertain when the sun goes down
- **Infrared Heaters** to make the area more comfortable on those chilly days and nights.
- **Fixed or Sliding Glass Side or Front Panels** to offer complete weather protection around the front or the sides.

Standard Colours

RAL COLOUR	FINISH
Anthracite Grey RAL 7016 	Textured Only

Options



RGBW
LIGHTING IN
MAIN BARS



INFRARED
HEATERS
AVAILABLE



150MM X 150MM
POST AVAILABLE

Heating & Lighting

See pages 35-40 for more information on the heating and lighting upgrades.

Victorian Upgrades

The Victorian Upgrade transforms the Simplicity range into ornate and beautiful shade and shelter structures which enhance the exterior of any building.

The Victorian Package has been our most popular upgrade, with the design features allowing for a true complimentary feel to both modern and traditional homes, and even commercial properties alike.

- **Decorative, Victorian style post upgrade which includes Post Sleeves and Gallows Brackets**
- **Ideal for domestic use to blend in with traditional style dwellings**
- **Provides a covered area that is in keeping with traditional or historical building styles**
- **Can be coloured to any standard colour to match the canopy and surrounding area**
- **Manufactured from robust aluminium**

Amongst the optional upgrades we provide are the Victorian Gallows Brackets and Base Castings which are colour matched in our powder coat finish to allow for seamless integration.

Testimonial

"We looked at several veranda systems, but wanted something to complement our old house, the Victorian upgrade for top gallows brackets really do add a touch of class to the standard Simplicity system and turn a plain design into one with character, which nicely blends in with the character of the house."

.....
DOMESTIC CUSTOMER





Heating

Infrared Outdoor Heaters

The infrared wall mounted heaters have ceramic elements that are designed to gently warm users whilst outdoors under a covered structure such as a canopy using Far Infrared technology which is completely harmless and contains no ultraviolet radiation or fumes.

The heaters also do not emit any noise and provide a gentle heat similar to the feeling of the winter sun.

You can enjoy keeping warm outside without feeling too hot and without experiencing any unsightly glare.

The ceramic plates generate heat quickly and reach their full operating temperature within less than 10 minutes.

Each unit is supplied with a 5-year warranty and requires no maintenance. They are CE certified and carry the UL safety recognition (file no. E214574) when installed by an approved electrician.

Size:

Available with 2 or 3 heated elements to create medium or large heated areas with a choice of different power outputs.

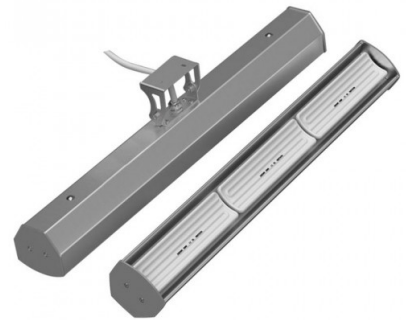



Keep your veranda or glass room warm throughout the year with our heating products

Modular Heaters & LED Lights

Our unique modular heaters and LED Lights offer individual combinations for every project.

Not only do they complement all our veranda, canopy or glass room systems, but they are easy to install and fully waterproof. Combine single modules or standard sets to every desired colour and length – 10, 20, 30, 50 or 100mm.

Choose from our standard colours pure Traffic White (9010), Jet Black (9005) and anthracite Grey (7016) or with a supplementary charge for an individual colour of your choice. Mounting brackets are included whether single modules or standard modular sets.

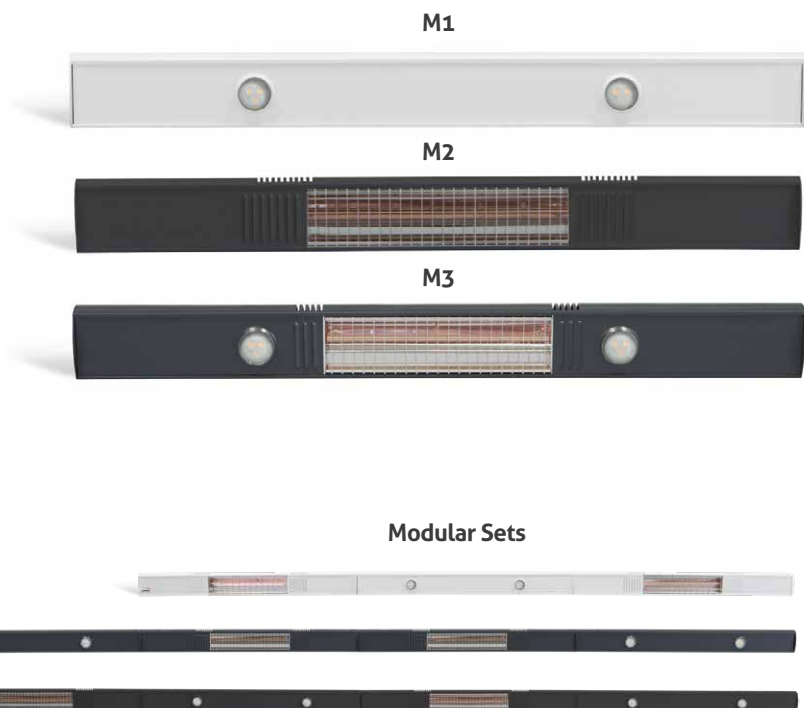

The units simply click together

LED Integrated Lighting

RGBW Lighting

Brighten up your veranda, canopy or glass room with the Integrated RGBW LED Lighting System.

This product must be installed by a qualified electrician.

- Integrated into the system seamlessly, our lighting system merges into the aesthetic when not in use.
- All wires are hidden within the canopy frame for a neat, tidy appearance.
- Enables users to use their canopy in the early morning or late evenings, when it may otherwise be too dark.
- The lights are fitted to the underside of the roof to light up the area underneath the structure.
- Operated by remote control for convenience.

4 Channel Remote Control



Battery operated, this gives you the facility to select which lighting colour is your preference from the Red, Green, Blue and White options. It also has a thumb wheel which allows you to sequence through the various colours. Using this remote also allows you to increase and dim the lighting to suit your choice.

SMART Receiver



Upgrade to the smart receiver which gives you the facility to operate your lighting from a Remote Control, your mobile phone or even Alexa!

RGBW Lighting Strip



The LED strip is Red, Green, Blue and White and every colour in between. The Power Consumption is 18W per metre. So, whatever the total length of your RGBW strips then multiply by 18 and you have the total wattage required to adequately power your system.

**Don't be left in the DARK!
Our New RGBW Lighting is HERE!**



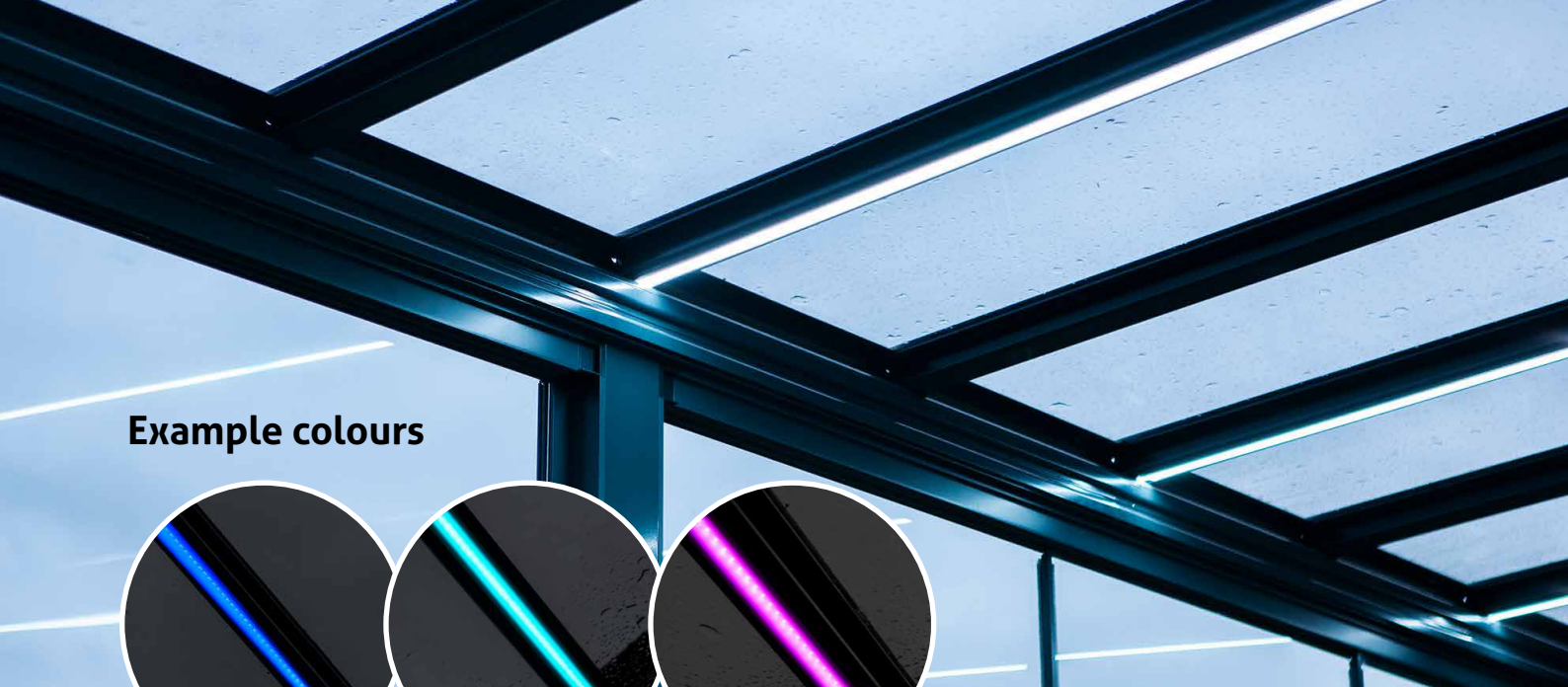

Example colours



4 Channel Wireless Wall Switch Control

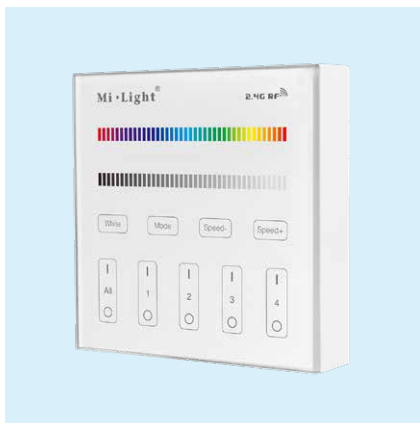

For ultimate control, upgrade to the 4 Channel Wireless Wall Switch enabling you to operate all the lighting features, changing colours and light brightness all from a touch pad on your wall.

Standard Receiver



With the standard receiver you can operate your remote control.

LED Driver 100W/150W/200W



Having worked out the total wattage (as above) you can now select the appropriate driver or drivers to power your system. This controls the voltage going to your lights so always ensure your driver(s) output is greater than the total wattage required.

LED Driver Specification – select from the drivers below, can be more than one, so that the total output of your drivers is greater than the wattage required.

- 100w Driver
- 150W Driver
- 200W Driver

Gewiss Electrical Box



- 190x140x70mm Plastic
- Rated at IP44/IP56 meaning it's both dust and water resistant
- Available in various styles, including pre-glanded entry (IP44), low lid and high lid (IP56)
- Screw down lid
- Constructed from technopolymer plastic to RAL7035
- Halogen free

LED Spotlights



Enhance Veranda Lighting with our Integrated Spotlights Upgrade

Bring endless light to your veranda, canopy, or glass room installations with the use of our Spotlight Upgrade when you order one of our Simplicity Xtra or Sim Free models. Providing a contemporary look, these will be a great addition to any outdoor living space project.

- Our Spotlight systems are integrated into the veranda, enhancing the aesthetic while in use and almost unnoticeable when turned off
- All wires are hidden within the veranda frame for a seamless appearance
- The lights are Integrated into the bolster bar to give it a sleek finish
- Operated by remote control for convenience
- Enable customers to use their veranda in the early morning or late evenings, when it would usually be too dark

Testimonial

"We opted to incorporate the Spotighting into our new Simplicity Xtra system to create additional lighting in the darker months. We liked the design and how the spotlights were built into the framework and hidden from view. We're extremely happy with our choice and would recommend to future buyers."

.....
DOMESTIC CUSTOMER

Features & Benefits

- Aluminium Finish
- 3000k (Warm White)
- Dimmable lighting options
- Additional lighting in the darker months
- Integrated and hidden within the bars
- Operated by remote control
- Contemporary look



Licensed electricians are required to install the Spotlighting Upgrade for Sim Xtra or Sim Free models to ensure full functionality and compliance.

Technical Specifications

FITTING TYPE	SMD LED
Voltage	CV 700Ma
Wattage	3W
Lumens	WW – 200Lm
Colour Temperature	WW – 3000k
IP Rating	IP64
Finish	Aluminium
Plug Type	AMP
Cable Length	200mm
Mounting	Recess
Dimensions	33 x 50mm

We provide installation guides and videos to assist you with the installation process, allowing you to incorporate the lights into our system on site. These can be found in the Trade Partner Area.

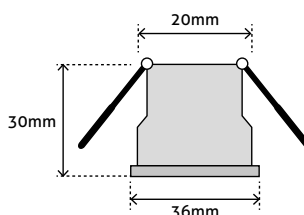

Recessed downlights compatible with Somfy 10



- Warm white light (2700K)
- 3 watt per spot
- Cree LED
- Dimmable
- Light angle 45
- Recessed downlight
- 5 metre cable
- IP65
- Connected in series
- Sets of 6, 8, 10, and 12

A-Fence Aluminium Fencing

Manufactured entirely out of aluminium, A-Fence will revolutionise the fencing market. Requiring very few components to achieve an effective and robust installation, the fire-safe A-Rated aluminium design will be catching the eyes of architects, developers and, of course, homeowners across the country.

A-Fence achieves A2-s1, d0 fire rating, proving its non-combustibility. The shift towards using non-combustible materials in recent years across the construction industry has underlined the importance of the choices we make in regard to the materials we use to prevent any costly future remediation.

Among the drawbacks of wood in fence panels is its tendency to absorb moisture in rainfall. This causes them to expand and contract, gradually forcing their support panels to shift out of place and the panels to warp.

Aluminium, of course, is non-porous so does not absorb water, eliminating the fear of support panels shifting, warping or being dislodged.

Components include:

- 3 sizes of fence slats; 50mm, 100mm, 150mm
- 2 or 4-way post to allow for changes in direction at corners
- Inner Post to be fixed to ground
- Inner Post Cover to hide the fixings from view
- Spacer Cover Strips
- Post Top Cap
- Retaining Clip to seal panels in place, preventing them from flying out or losing shape
- Fixings will be supplied



50mm Fence Slats





100mm Fence Slats



150mm Fence Slats

Standard colours

RAL COLOUR		FINISH
Anthracite Grey RAL 7016		Textured Only
Jet Black RAL 9005		Textured Only



**Robust and fire-safe aluminium fencing
to modernise your home**

Offering an extensive range of outdoor living products

Verandas



Glass Rooms



Fencing



Glazing Systems Ltd Unit 2 Acorn Business Centre
Butts Street, Leigh, Lancashire WN7 3DD
Tel: 01942 871183

